



Russian Association of TRIZ

The International Public University of TRIZ



Formula Of The Concepts Definition

and Its Application to Basic
Concepts of Contemporary TRIZ

Especially for:

TFC 2018

Automated Invention for Smart Industries

Evgeniy E Smirnov

PhD, Certified
specialist of TRIZ

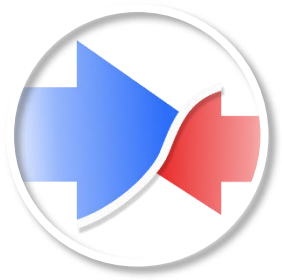

Semantics

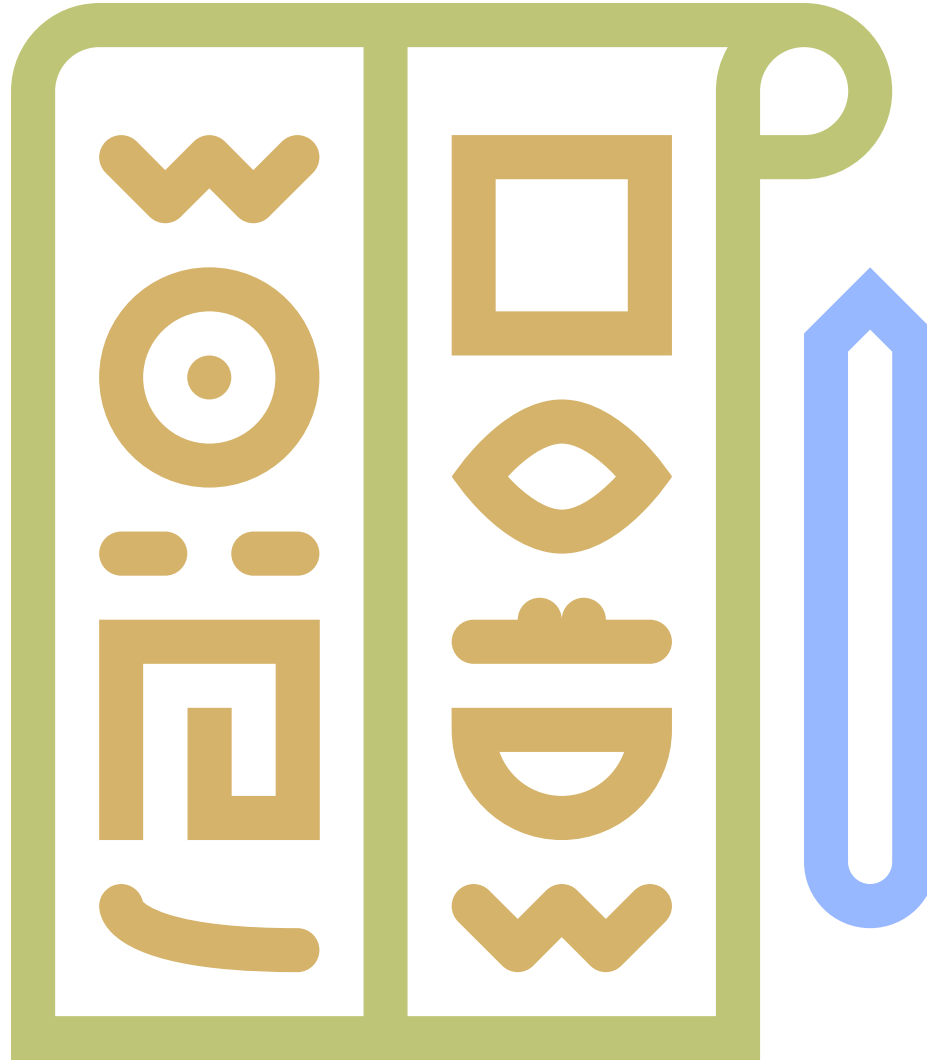

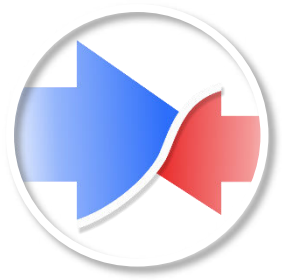

Example: cutting arc

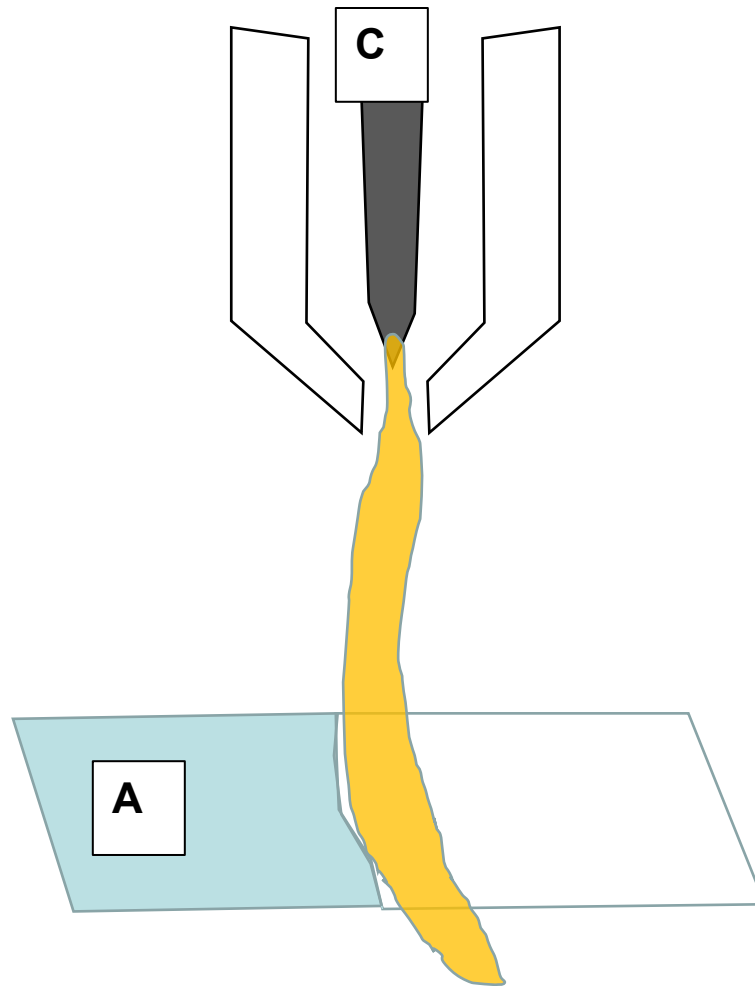



«Ceci n'est pas une pipe»



René François Ghislain Magritte, La trahison des images, 1928–1929

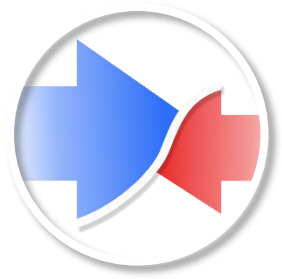

Misunderstanding

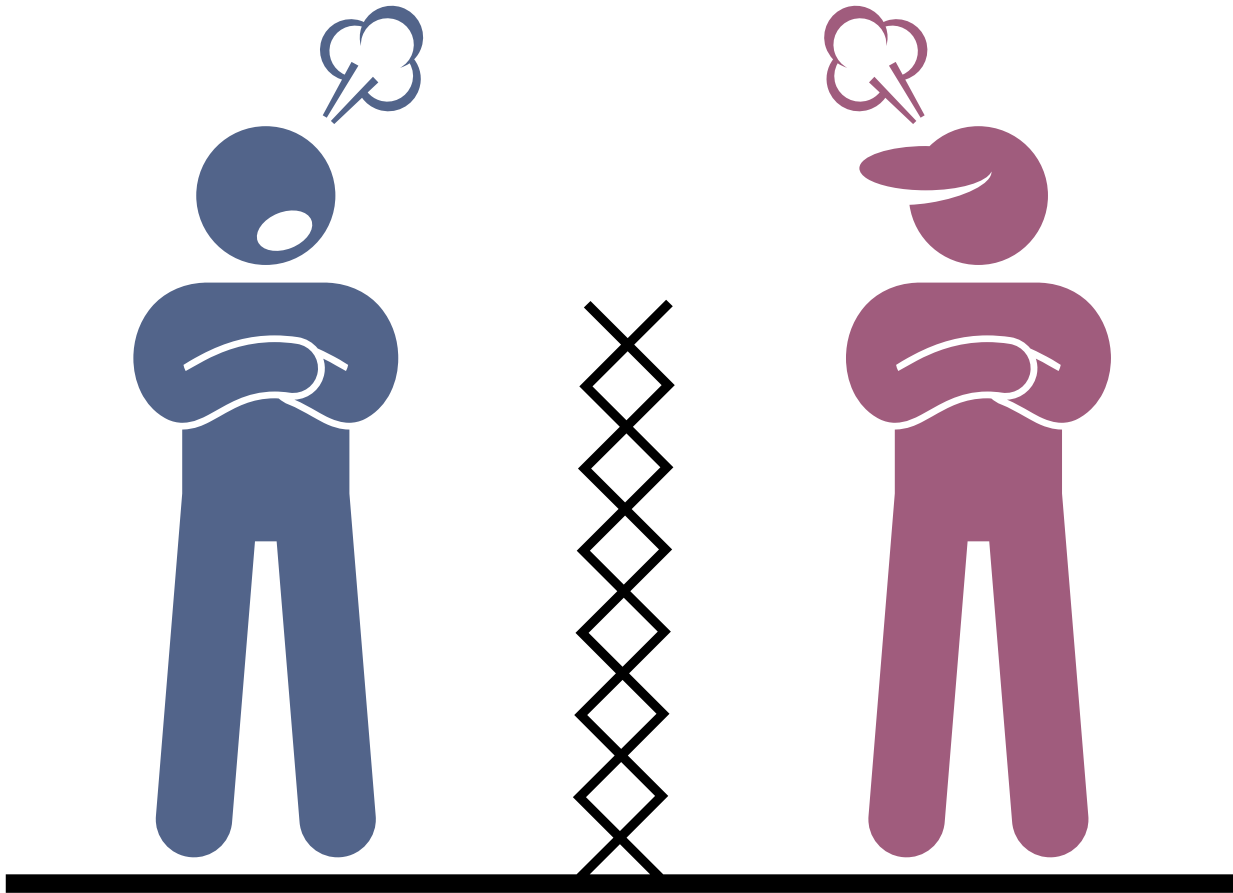

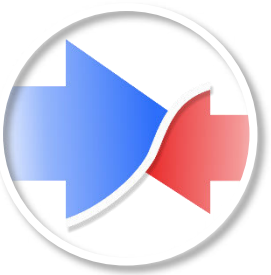

Semantic Triangle

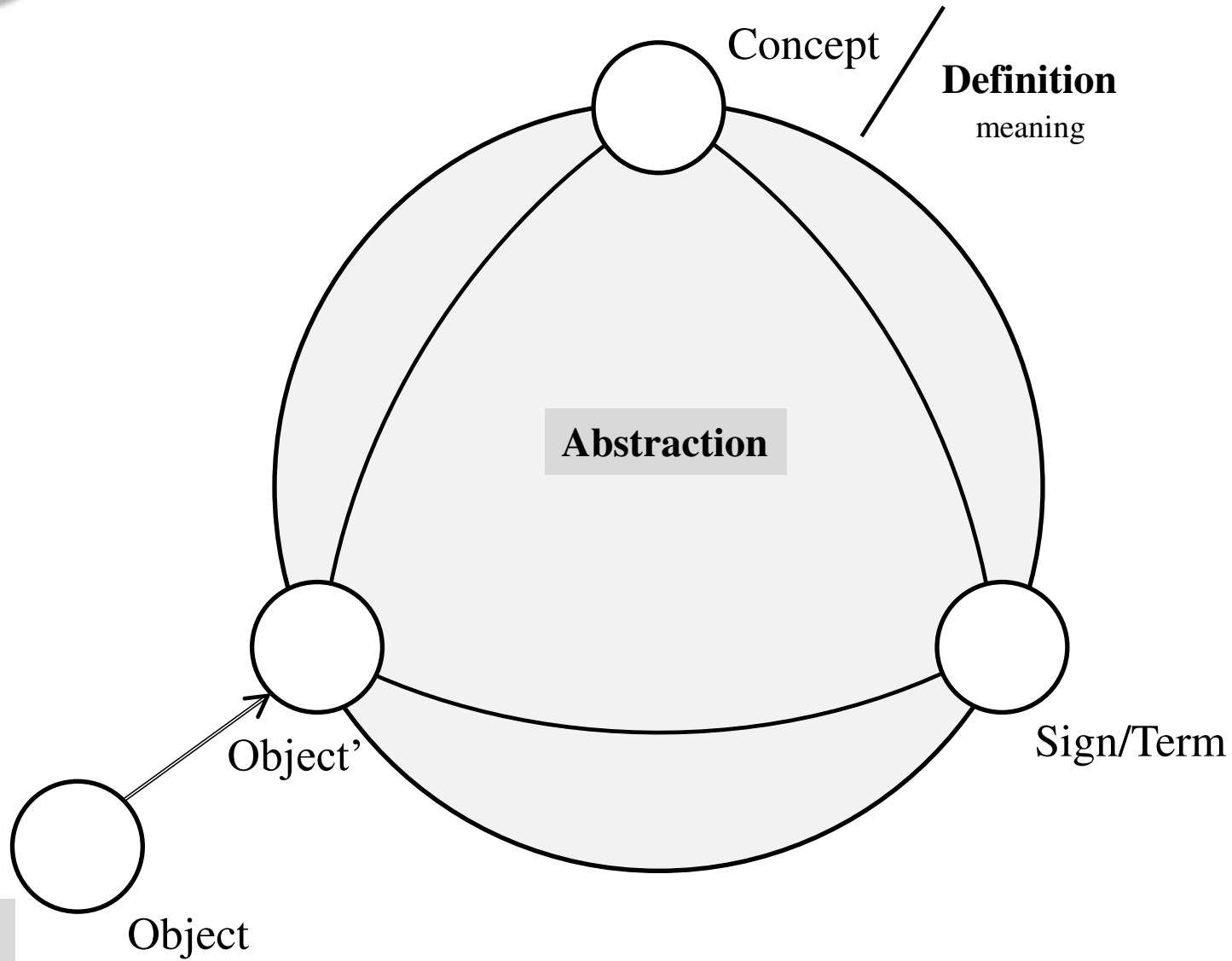

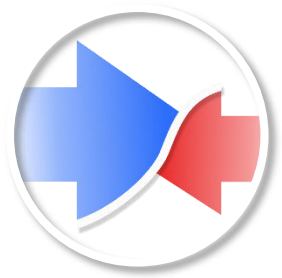

The minimum composition of FS

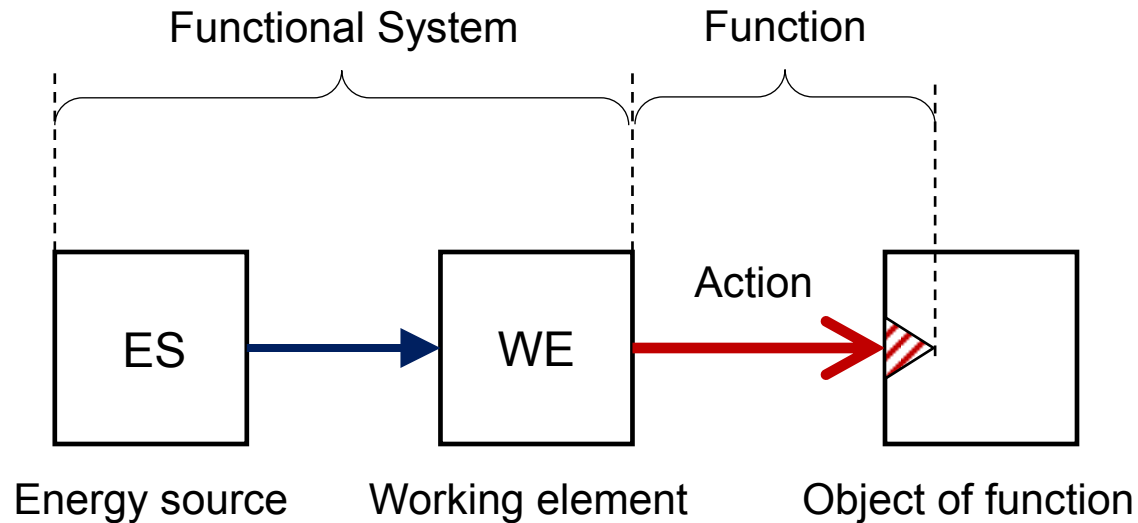

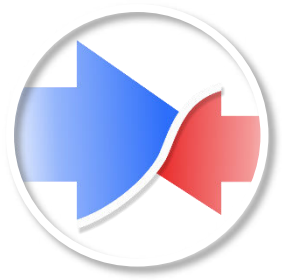

Simplified model of interaction

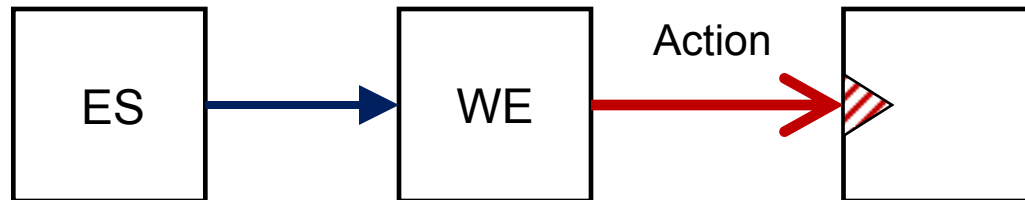
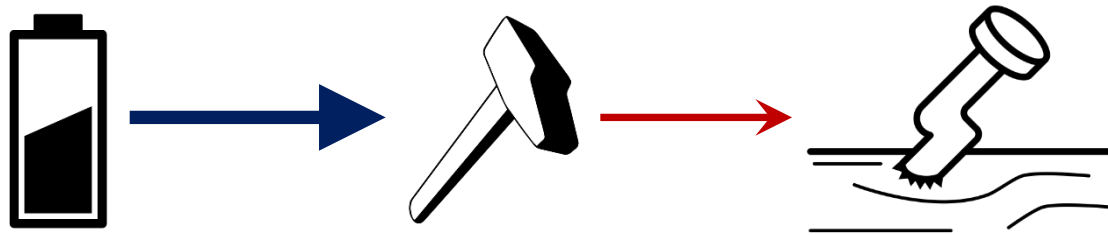

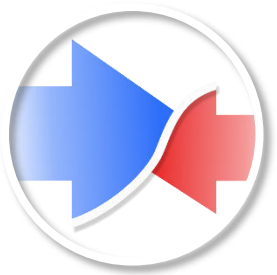

The "Complete" FS

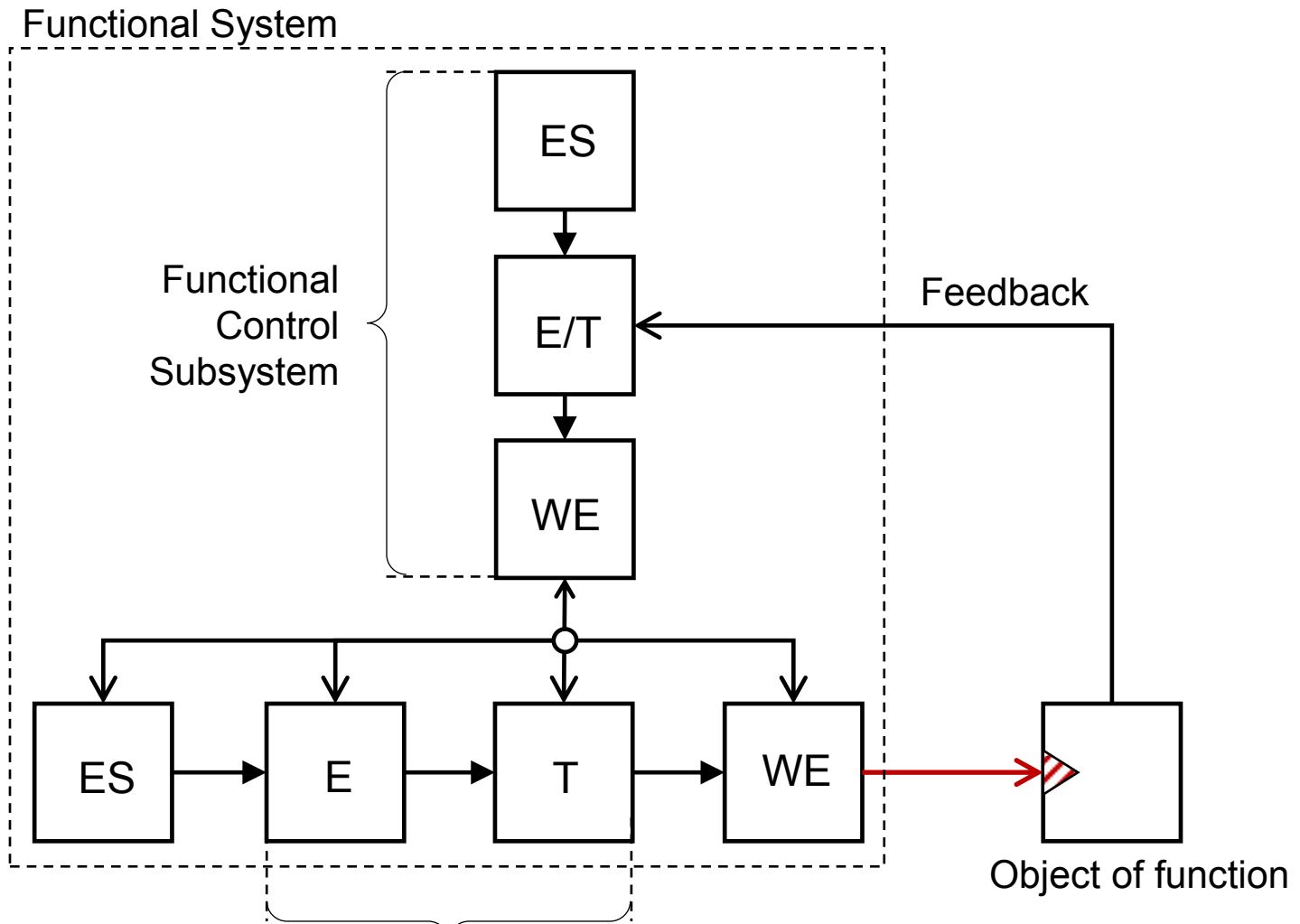

Converters of Energy: 1st kind – “engine” (E)
2nd kind – “transmission” (T)



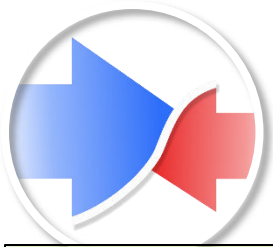

Converters of Energy

1st kind – “engine” (E)

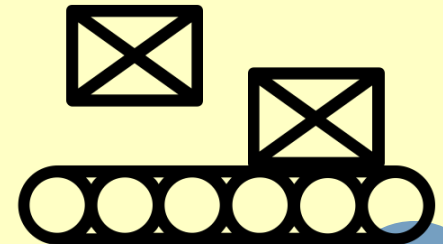
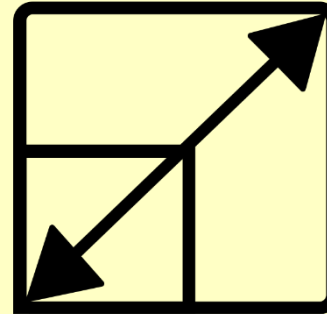
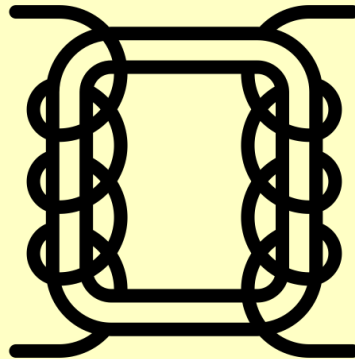
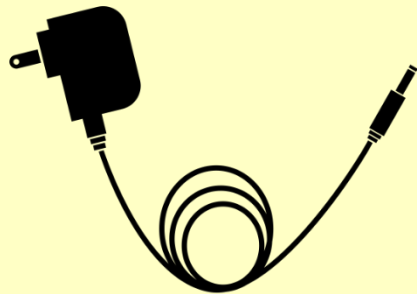
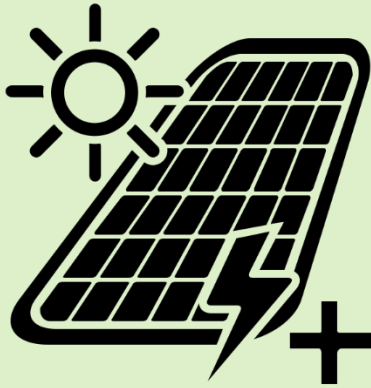

2nd kind – “transmission” (T)

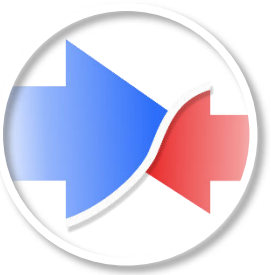

Functional system

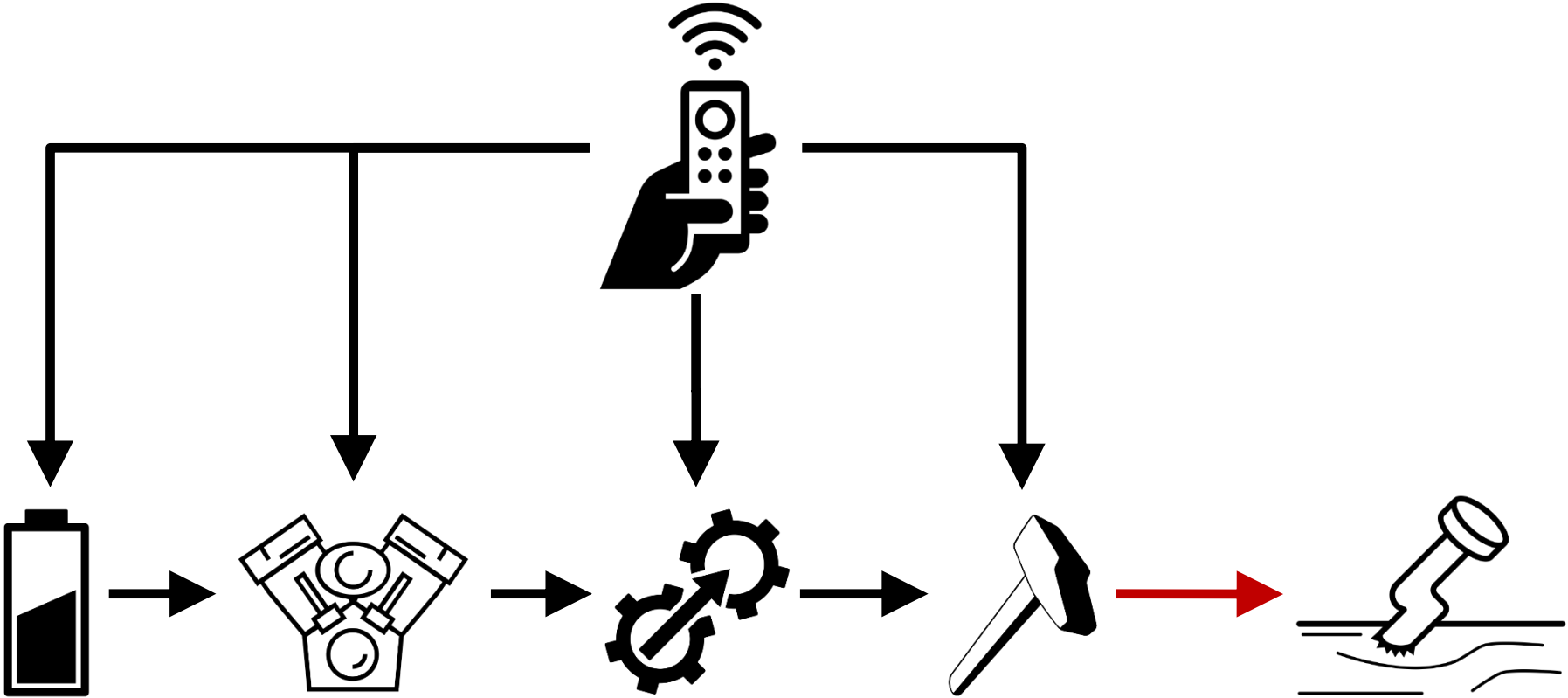

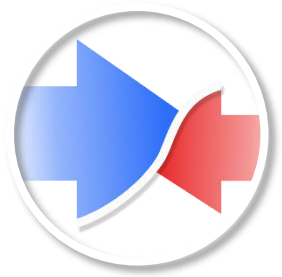

The basis of the formula

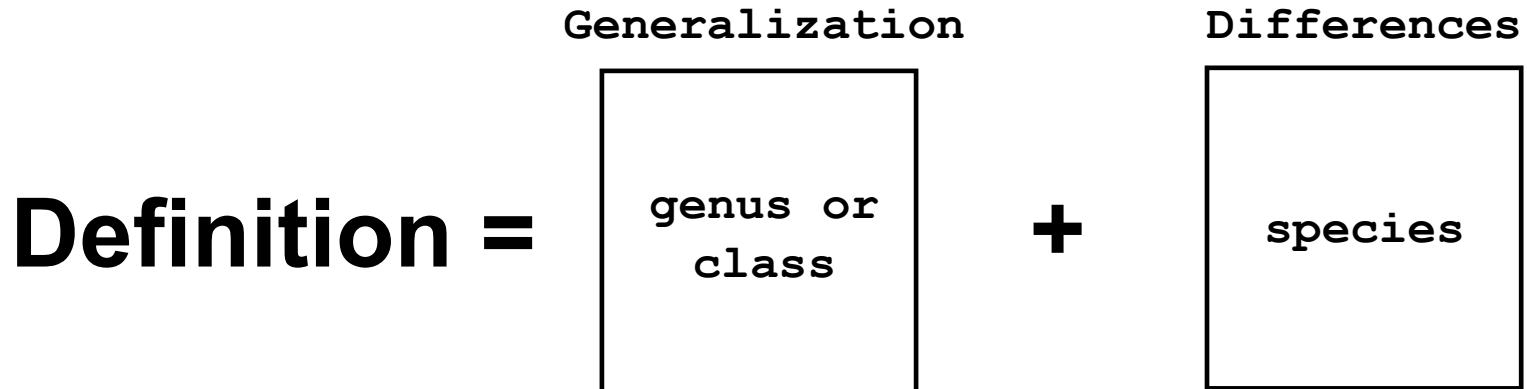

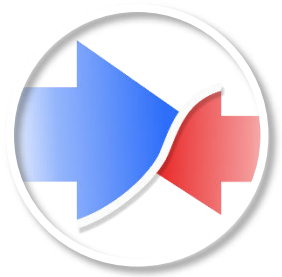

The basis of the formula

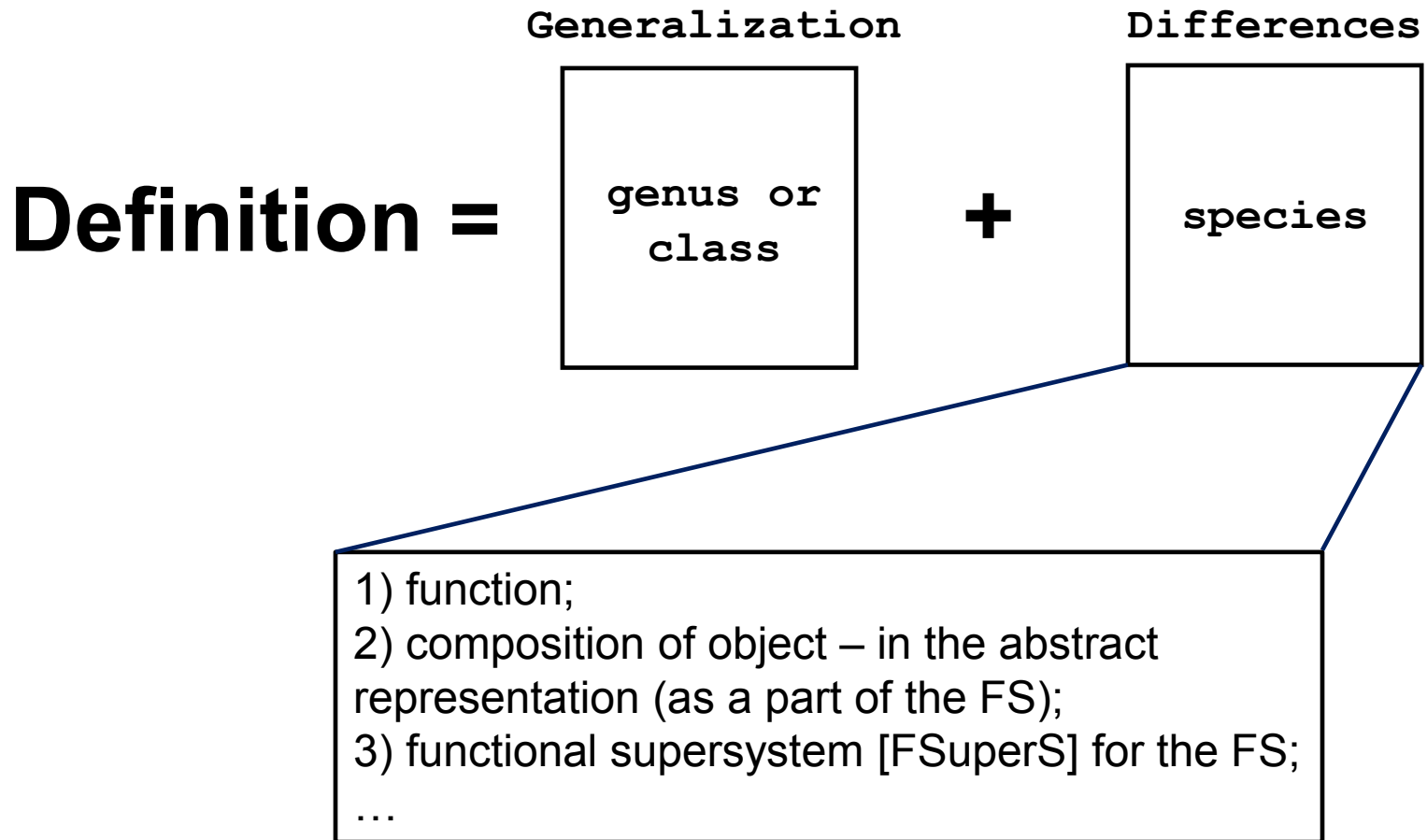

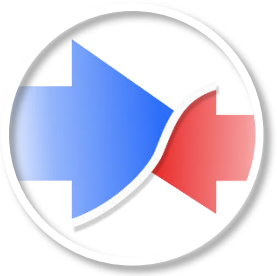

System hierarchy

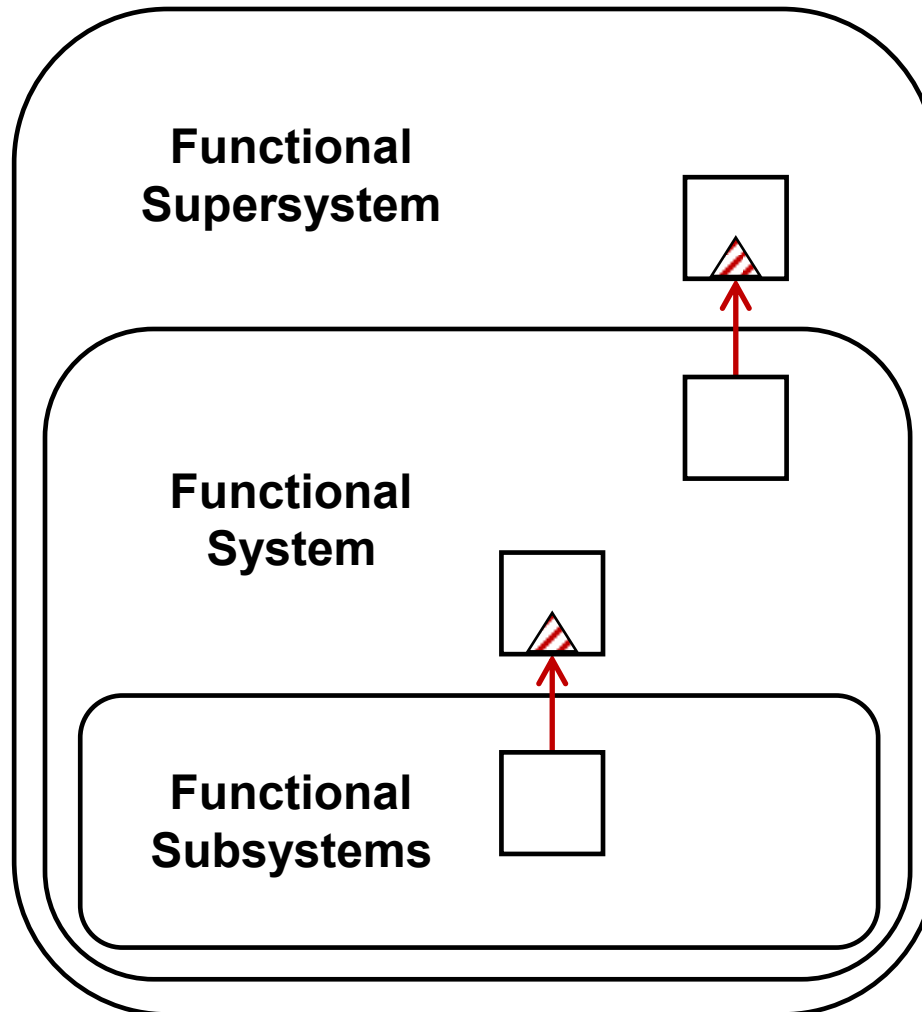

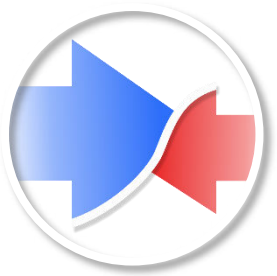

NIPU-cycle

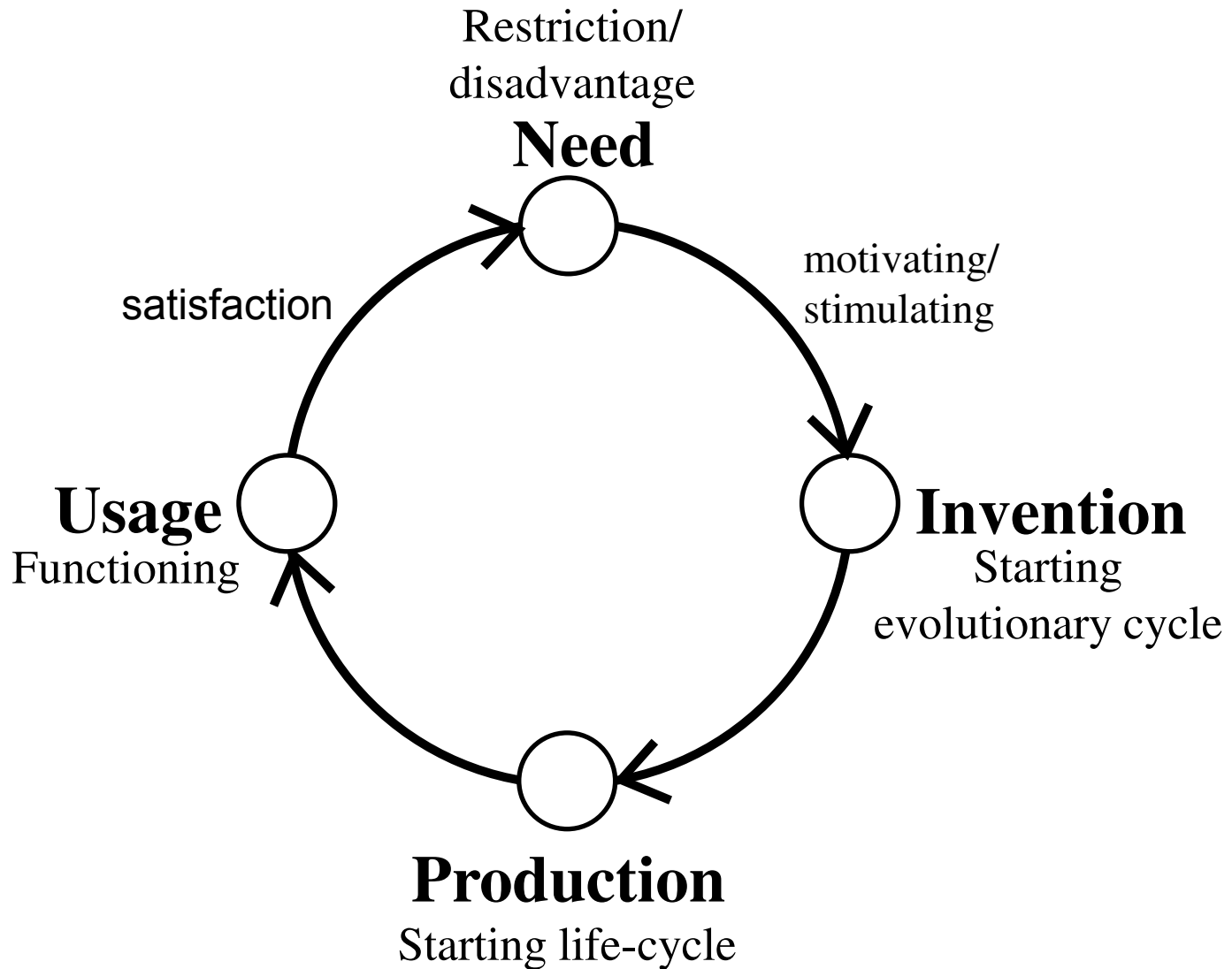

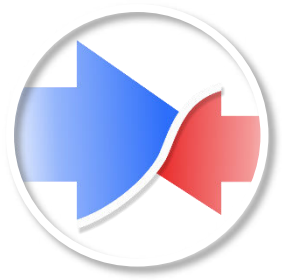

Example: cutting arc

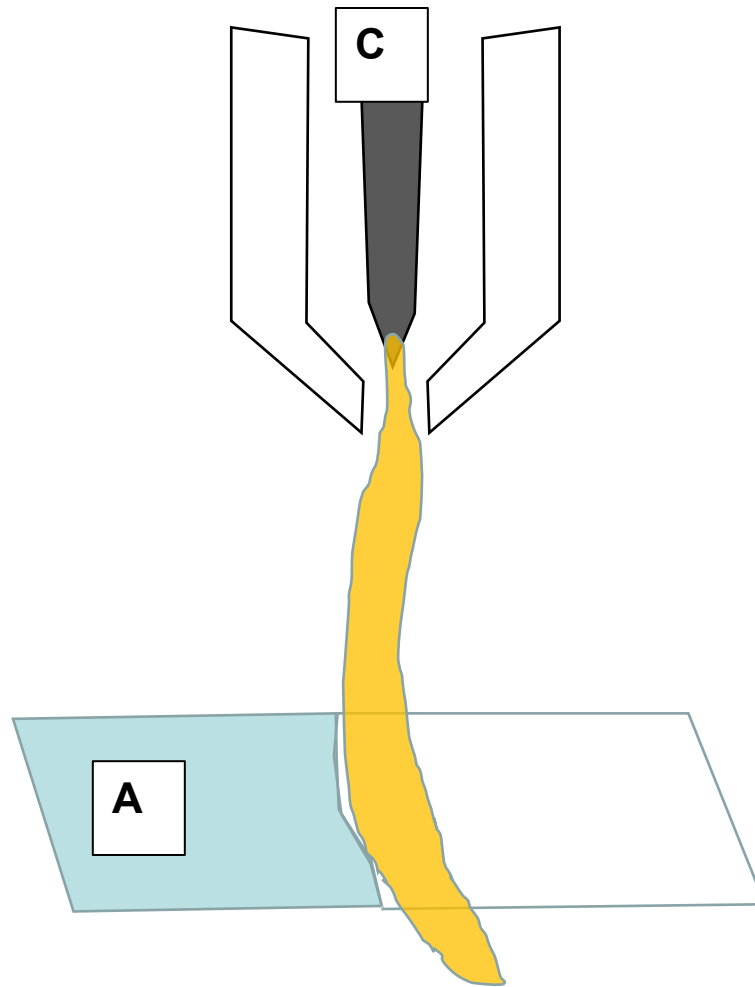

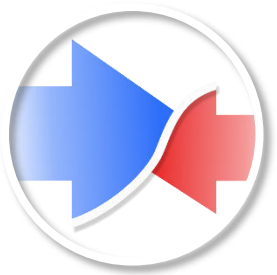

Contradiction of Conditions

Functional definition

CC

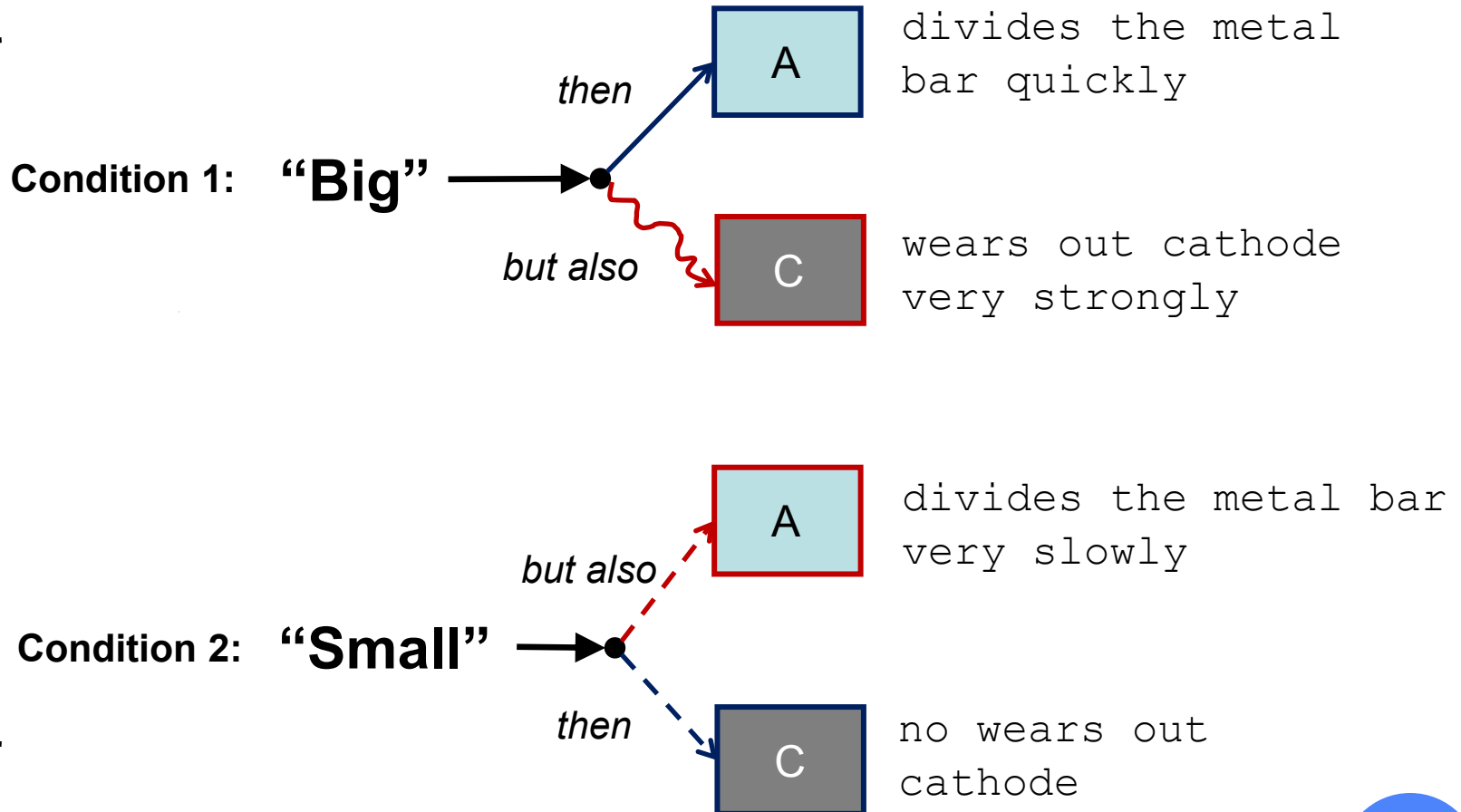

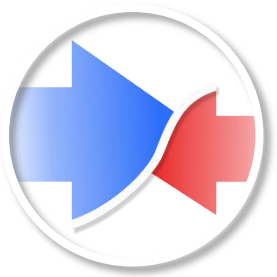

Contradiction of Conditions

Alternative representation

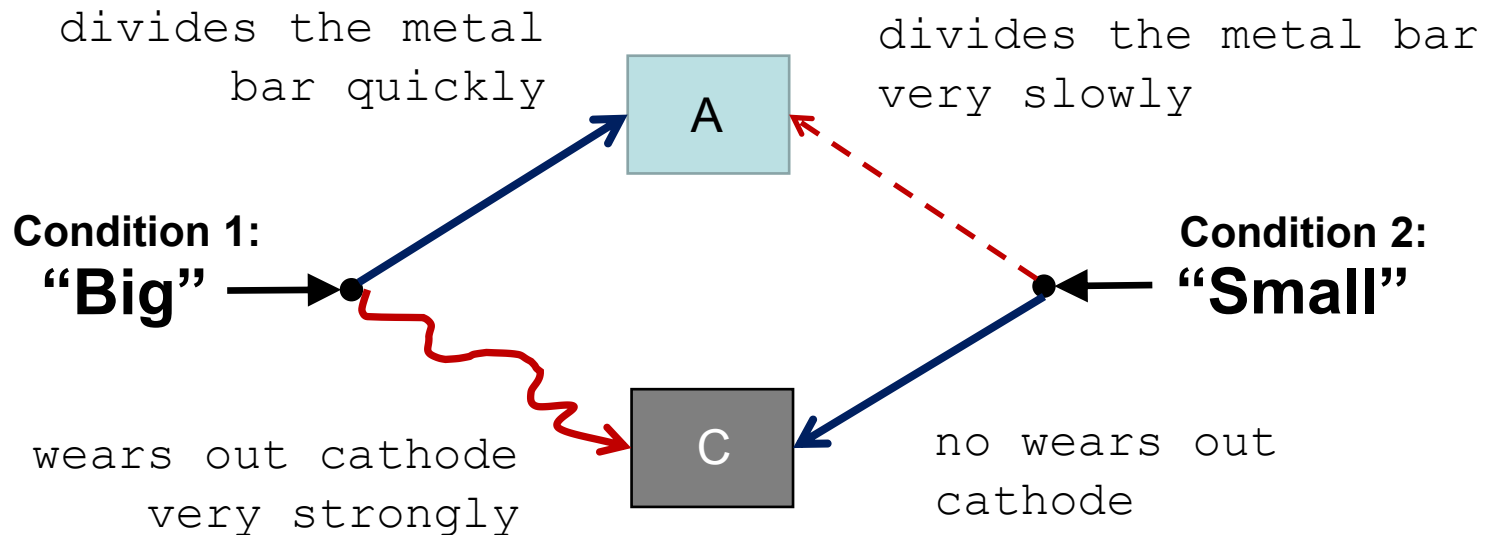

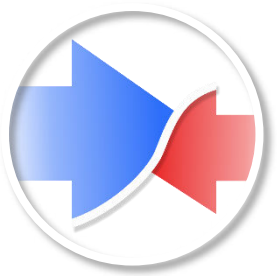

Contradiction of Conditions (CC)

General version

Contradiction
of Conditions

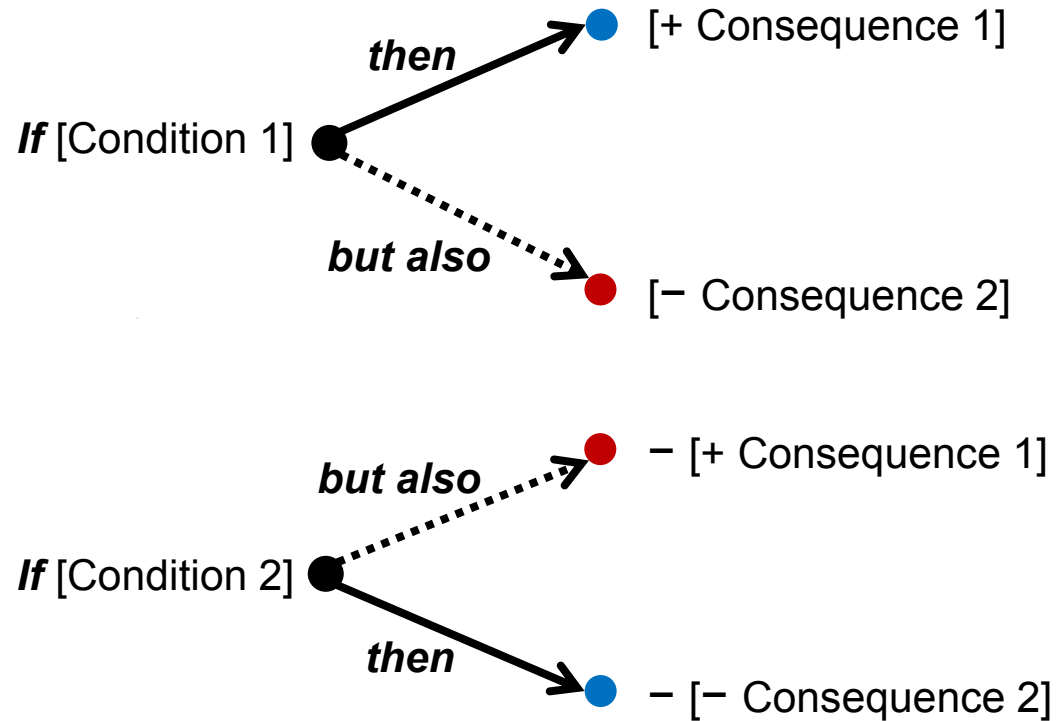

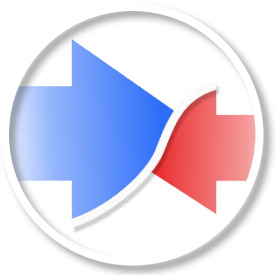

Transition from \mathcal{CC} to \mathcal{CR}

From “if-style” to “must-style”

CC

Condition 1: “Big”

then

A

divides the metal bar quickly

but also

C

wears out cathode very strongly

Condition 2: “Small”

but also

A

divides the metal bar very slowly

then

C

no wears out cathode

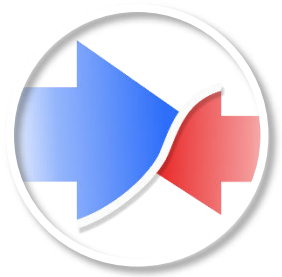

Contradiction of Requirements (CR)

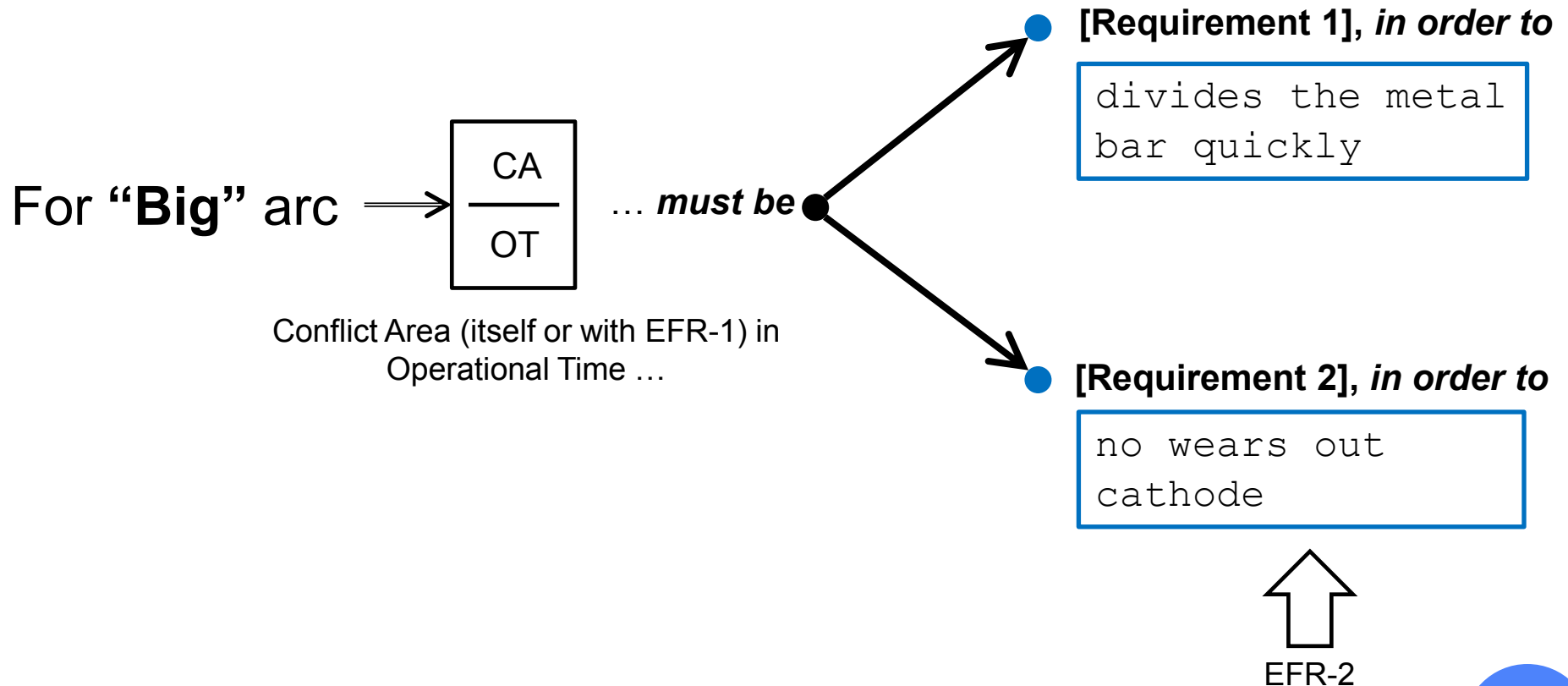

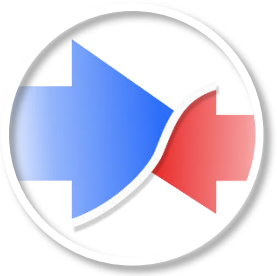

Contradiction of Requirements (CR)

General version

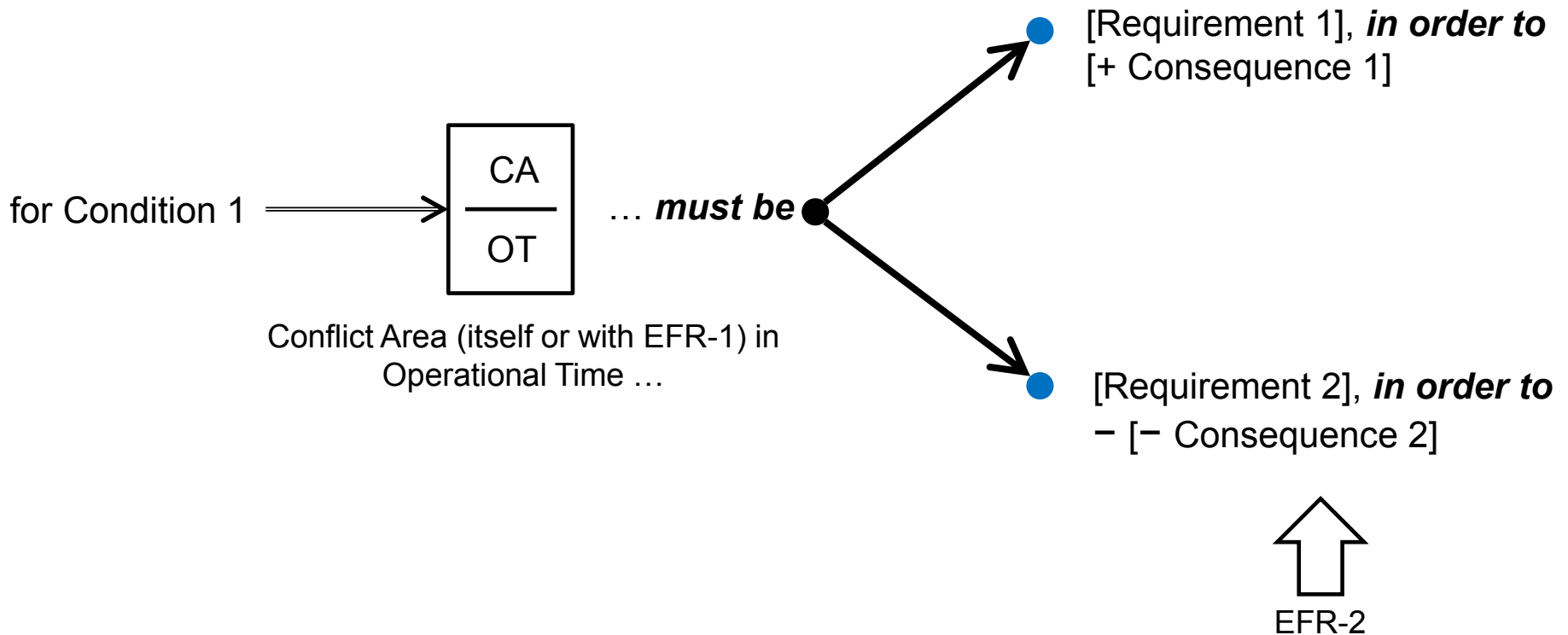

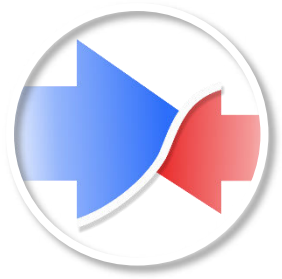

Understanding

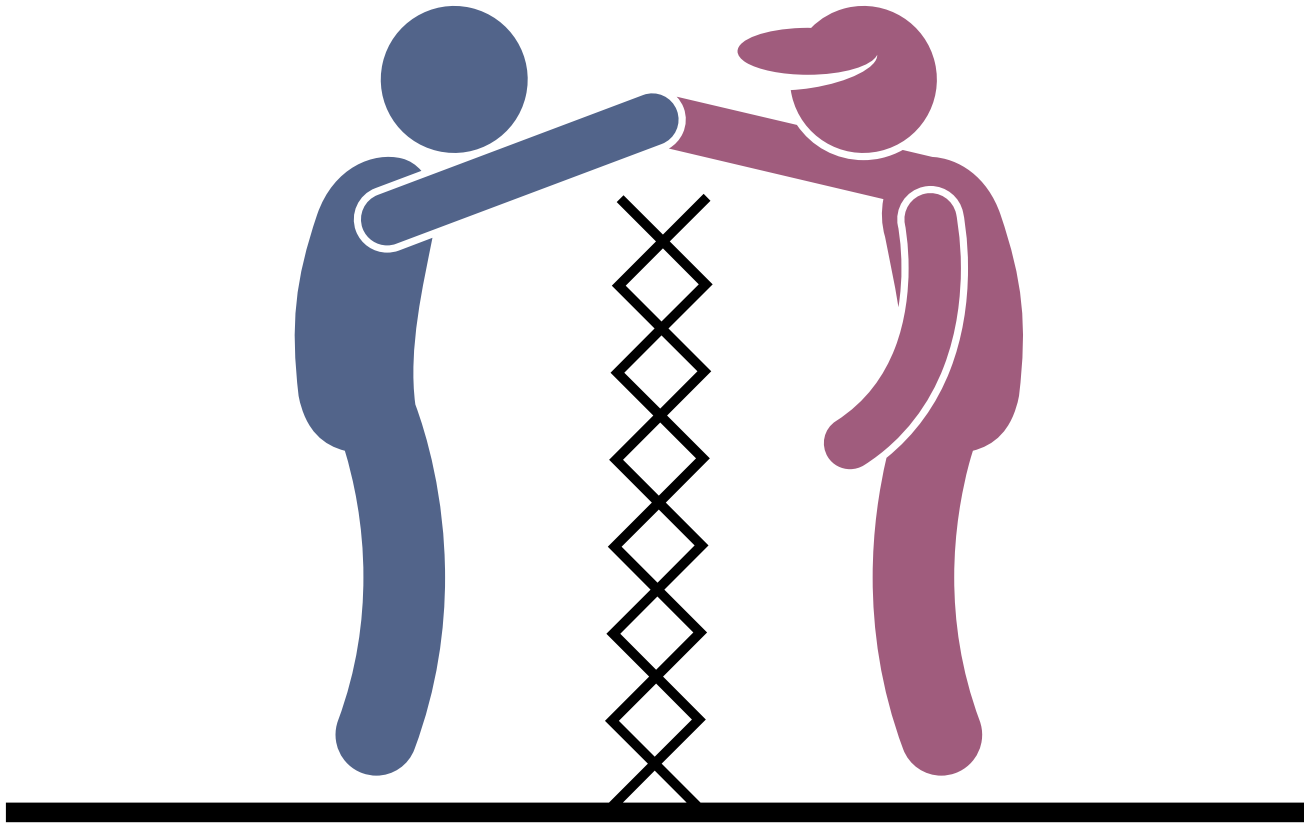

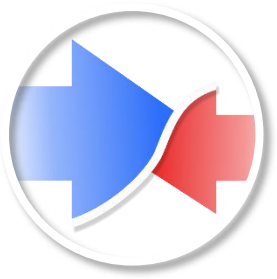

*Thank you for your
attention!*

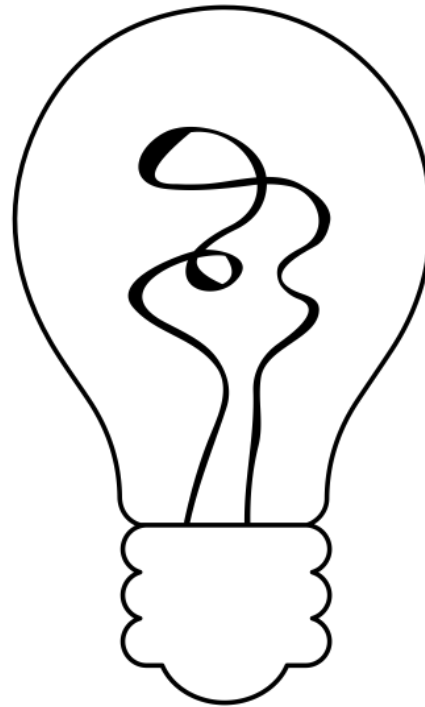

TRIZ-ON@mail.ru